

---

# Kodak EasyShare V1233 zoom digital camera



## User's guide

[www.kodak.com](http://www.kodak.com)

For interactive tutorials:

[www.kodak.com/go/howto](http://www.kodak.com/go/howto)

For help with your camera:

[www.kodak.com/go/v1233support](http://www.kodak.com/go/v1233support)

---

# Kodak

Eastman Kodak Company

Rochester, New York 14650

© Eastman Kodak Company, 2007

All screen images are simulated.

Kodak, EasyShare, and Perfect Touch are trademarks of Eastman Kodak Company.

4J6232\_en

## Front view

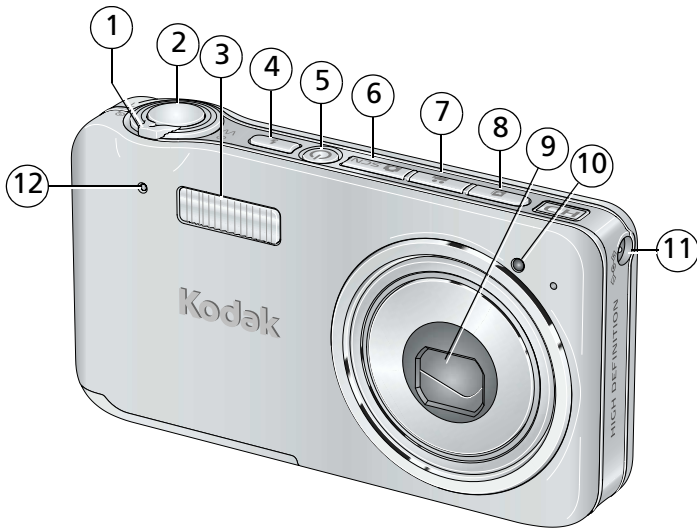

- |   |                              |    |  |
|---|------------------------------|----|--|
| 1 | Zoom lever (W/T)             | 7  | Video mode button                            |
| 2 | Shutter button               | 8  | Favorites mode button                        |
| 3 | Flash                        | 9  | Lens   |
| 4 | Flash button                 | 10 | Video light/Self-timer light/AF assist light |
| 5 | On/Off button                | 11 | DC-In (5V)                                   |
| 6 | Auto/SCN (scene) mode button | 12 | Microphone                                   |

NOTE: 6, 7, and 8 are also Battery Charging lights.

## Back view

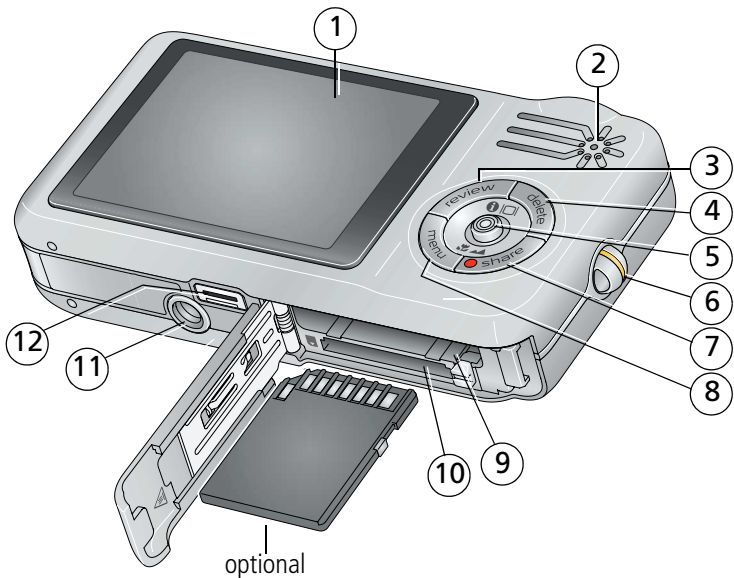

- |   |  |    |                                  |
|---|--|----|----------------------------------|
| 1 | LCD  | 7  | Share button                     |
| 2 | Speaker  | 8  | Menu button                      |
| 3 | Review button  | 9  | Battery compartment              |
| 4 | Delete button  | 10 | Slot for optional SD or MMC card |
| 5 | Joystick   ; OK button (press) | 11 | Tripod socket                    |
| 6 | Strap post   | 12 | USB, A/V Out, Dock connector     |

---

# Table of contents

<b>1</b>	<b>Setting up your camera</b>	<b>1</b>
	Attaching the strap	1
	Loading the KLIC-7004 battery	1
	Charging the battery	2
	Turning on the camera	3
	Setting the language and date/time	4
	Storing pictures on an SD or MMC card	4
<b>2</b>	<b>Taking pictures/videos</b>	<b>5</b>
	Taking a picture	5
	Using the framing marks to take pictures	6
	Taking a video	6
	Using the 3X optical zoom	7
	Using the self-timer	8
	Using the flash	9
	Using different modes	10
	Using camera Help	13
	Understanding the picture-taking icons	13
<b>3</b>	<b>Working with pictures/videos</b>	<b>14</b>
	Reviewing pictures/videos	14
	Deleting pictures/videos	15
	Using the menu button in review	16
	Cropping pictures	17
	Adding sound tags	17
	Using Kodak Perfect Touch technology	18
	Editing videos	19
	Running a slide show	22
	Viewing pictures/videos in different ways	25
	Selecting multiple pictures/videos	26
	Copying pictures/videos	27

Understanding the blur warning icons .....	27
Understanding the review icons.....	28
<b>4 Doing more with your camera .....</b>	<b>29</b>
Using the menu button to change settings.....	29
Customizing your camera .....	34
Taking panoramic pictures.....	37
Using exposure compensation to adjust picture brightness .....	38
Using the histogram to view picture brightness .....	38
Using the framing grid to compose a picture.....	38
Sharing your pictures.....	39
<b>5 Transferring and printing pictures .....</b>	<b>45</b>
Installing the software.....	45
Transferring pictures/videos .....	46
Printing pictures .....	47
Dock compatibility for your camera.....	49
<b>6 Troubleshooting .....</b>	<b>50</b>
<b>7 Getting help .....</b>	<b>54</b>
<b>8 Appendix .....</b>	<b>56</b>
Camera specifications .....	56
Care and maintenance .....	58
Upgrading your software and firmware.....	59
Storage capacities .....	59
Important safety instructions .....	59
Battery replacement, battery life .....	60
Limited warranty .....	61
Regulatory compliance .....	63

# 1

## Setting up your camera

**IMPORTANT:** *For package contents, see your product package.*

### Attaching the strap

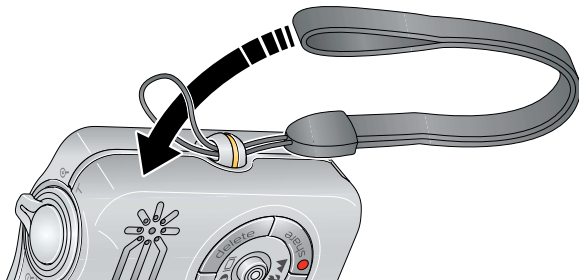

### Loading the KLIC-7004 battery

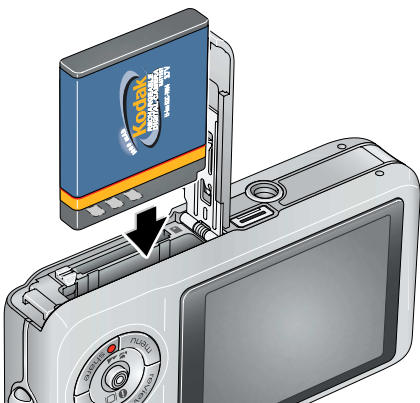

For information on replacing batteries and extending battery life, see [page 60](#).

## Charging the battery

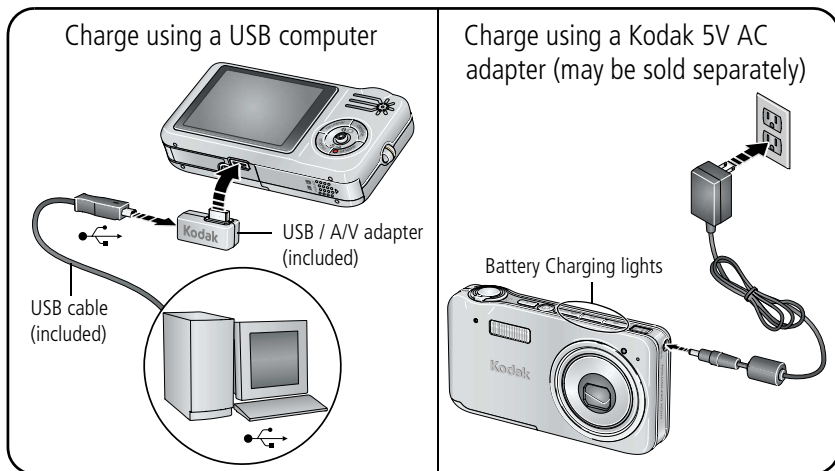

### Charge until all 3 Battery Charging lights are lit.

If the Battery Charging lights do not turn on during USB charging, ensure:

- The USB cable is connected to a powered USB port
- The computer is turned on, and not in sleep mode

For more on USB charging, visit [www.kodak.com/go/USBcharging](http://www.kodak.com/go/USBcharging).

To purchase accessories, visit [www.kodak.com/go/v1233accessories](http://www.kodak.com/go/v1233accessories).



## Charging the battery using other accessories

**Kodak EasyShare camera or printer dock;**  
**Kodak EasyShare HDTV dock;**  
**Kodak EasyShare photo frame dock 2**  
(May be sold separately.)

For details, see the dock user's guide. For dock compatibility, see [page 49](#).

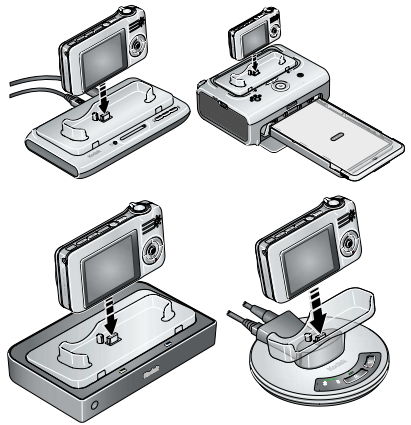

## Turning on the camera

Press the On/Off button to turn the camera on in Auto mode.

NOTE: You can also press the Auto/SCN, Video, or Favorites button to turn on the camera in that mode.

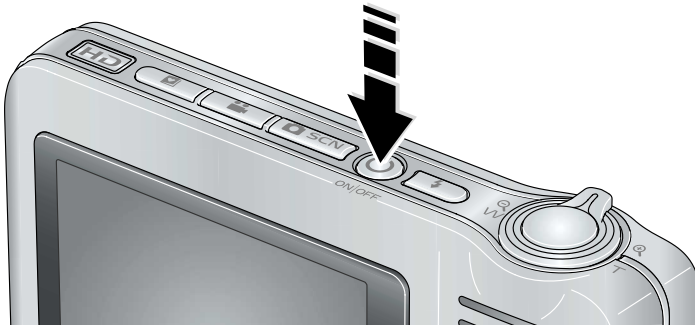

## Setting the language and date/time

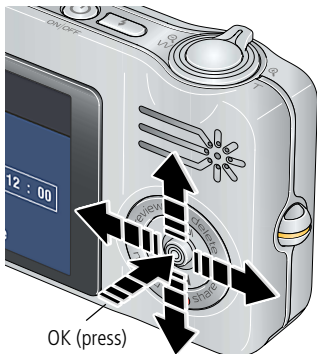

### Language:

- 1 ▲/▼ to change.
- 2 OK to accept.

### Date/Time:

- 1 At the prompt, press OK.
- 2 ▲/▼ to change.  
◀/▶ for previous/next field.  
OK to accept.

NOTE: To change language in the future, [see page 36](#). To change date & time, [see page 35](#).

## Storing pictures on an SD or MMC card

Your camera has internal memory. You can purchase an SD or MMC card to conveniently store more pictures/videos ([www.kodak.com/go/v1233accessories](http://www.kodak.com/go/v1233accessories)).



### CAUTION:

**A card can only be inserted one way; forcing it may cause damage. Inserting or removing a card while it is being accessed may damage the pictures, the card, or the camera.**

- 1 Turn off the camera.
- 2 Insert or remove the optional card.
- 3 Turn on the camera.

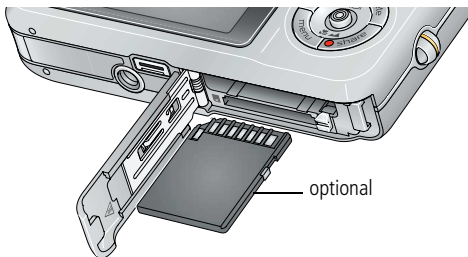

# 2

## Taking pictures/videos

### Taking a picture



- 1 Press the On/Off or Auto/SCN button to turn on the camera.
- 2 Compose the picture.
- 3 Press the Shutter button **halfway** to focus and set exposure. When the framing marks turn green, press the Shutter button **completely down**.

NOTE: You can repeatedly press Info/Display   to turn on/off status icons, histogram, and framing grid.

### Reviewing the picture just taken

After you take a picture/video, the LCD displays a quickview for approximately 5 seconds. (To exit the quickview sooner, press the Shutter button halfway.)

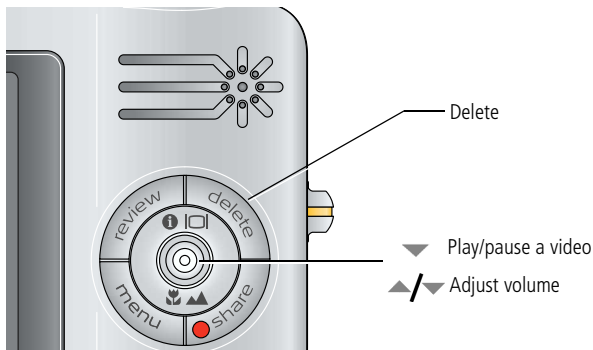

To review pictures/videos anytime, see [page 14](#).

## Using the framing marks to take pictures

Framing marks indicate the camera focus area. In Auto mode (and in SCN modes designed for pictures of people), the camera attempts to focus on faces.

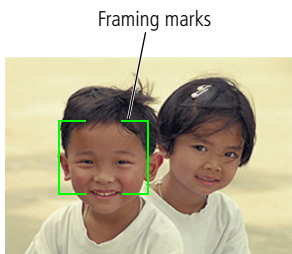

- 1 Press the Shutter button **halfway**.  
*When the framing marks turn green, focus is accomplished.*
- 2 If the camera is not focusing on the desired subject (or if the framing marks disappear), release the Shutter button and recompose the scene.
- 3 Press the Shutter button **completely down** to take the picture.

NOTE: Multiple framing marks may appear when faces are detected. Framing marks do not appear in Landscape or Video mode. When you use Focus Zone and set Center Zone, the framing marks are fixed at Center Wide.

## Taking a video

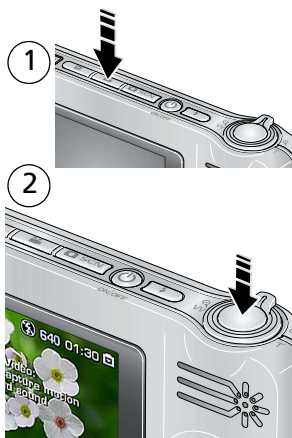

- 1 Press the Video mode button.  
*The camera enters Video mode.*
- 2 Press the Shutter button **completely down**, then release it. To stop recording, press and release the Shutter button again.

To review and work with videos, see [page 14](#).

## Using the 3X optical zoom

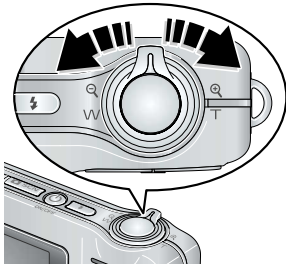

- 1 Use the LCD to frame your subject.
- 2 To zoom in, press Telephoto (T).  
To zoom out, press Wide Angle (W).  
*The zoom indicator shows the zoom status.*
- 3 Take the picture or video.

NOTE: For focus distances, see Camera Specifications starting on [page 56](#).

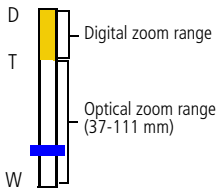

## Using digital zoom

Use digital zoom in any picture-taking mode to get up to 5X magnification beyond optical zoom. (You cannot use digital zoom for video recording.)

- 1 Press Telephoto (T) until the slider is at the top of the optical zoom range. Release Telephoto (T), then press it again.
- 2 Take the picture.

NOTE: You may notice decreased image quality when using digital zoom. The slider pauses and turns red when the picture quality reaches the limit for an acceptable 4 x 6-in. (10 x 15 cm) print.

## Using the self-timer

Use the self-timer when you want to be included in a picture or to ensure a steady Shutter button press. Place the camera on a tripod or flat surface.

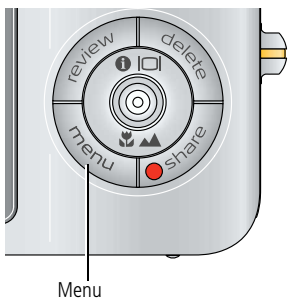

- 1 In any Still mode, press the Menu button.
- 2 Press ▲/▼ to highlight Self-Timer, then press OK.
- 3 Press ▲/▼ to highlight:
  - 10 seconds**—A picture is taken after a 10-second delay (so you have time to get into the scene).
  - 2 seconds**—A picture is taken after a 2-second delay (for a steady, auto-shutter release on a tripod).
  - 2 shot**—The first picture is taken after a 10-second delay. A second picture is taken 8 seconds later.
- 4 Press OK, then the Menu button.
- 5 Compose the scene.
- 6 Press the Shutter button **halfway**, then **completely down**.

*The camera takes the picture/pictures after the delay.*

NOTE: In Panoramic modes ([page 37](#)), only the 2- and 10-second options are available.

### Use the same procedure to take a video, but:

- Press the Video mode button .
- Press the Shutter button **completely down**.

NOTE: The video stops when no storage space remains. Only the 2- and 10-second options are available in video mode.

## Using the flash

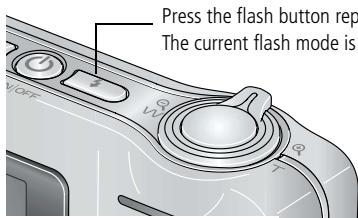





Press the flash button repeatedly to scroll through flash modes.  
The current flash mode is shown in the LCD status area.





Flash modes	Flash fires
<b>Auto</b>	When the lighting conditions require it.
<b>Fill</b>	Every time you take a picture, regardless of the lighting conditions. Use when the subject is in shadow or is "backlit" (when light is behind the subject). In low light, hold the camera steady or use a tripod.
<b>Red Eye</b>	In Red Eye flash, you can reduce red eye by using a preflash or by using automatic red eye reduction. To make the camera: <ul style="list-style-type: none"> <li>■ Preflash, turn the Red Eye Preflash on. (The first flash shrinks the eye pupil to reduce the chance of red eye.)</li> <li>■ Flash once and automatically remove red eye, turn the Red Eye Preflash off (<a href="#">see page 33</a>).</li> </ul>
<b>Off</b>	Never

Your camera saves the flash setting, even after you turn off the camera. To make the camera return to its default settings (such as Auto flash), turn off Maintain Settings ([see page 33](#)).

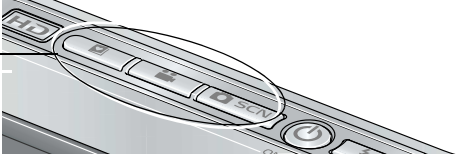
## Using different modes

Choose the mode that best suits your subjects and surroundings.

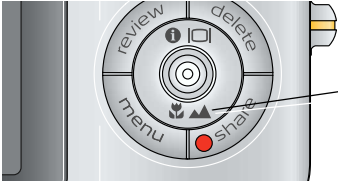
Use this mode	For
   <b>SCN Auto</b>	General picture taking—offers an excellent balance of image quality and ease of use.
   <b>SCN Scene</b>	Point-and-shoot simplicity when taking pictures in practically any situation. (See <a href="#">page 11.</a> )
	<b>Video</b> Capturing video with sound. (See <a href="#">page 6.</a> )
	<b>Favorites</b> Viewing favorite pictures. (See <a href="#">page 41.</a> )
Press a button to choose a mode.	

Use this mode	For
 <b>Landscape</b>	Far-away scenes. The camera uses infinity auto-focus. Auto-focus framing marks are not available in Landscape.
 <b>Macro</b>	Close range. The camera automatically sets the focus distance depending on the zoom position. Use available light instead of flash, if possible. (For Focus System/Distances, see <a href="#">page 57.</a> )
	Press  until the Macro or Landscape icon appears in the LCD status area.



## Using Scene (SCN) modes

Choose a Scene mode—for great pictures in practically any situation!

- 1 Press the Auto/SCN button until the Scene icons appear on the LCD.
- 2 Press ◀/▶ ▲/▼ to view scene mode descriptions.

*The date/time and the mode description appear. If the mode description turns off before you finish reading it, press the OK button.*

- 3 Press the OK button to choose a Scene mode.

SCN mode	For
<b>Portrait</b>	Full-frame portraits of people.
<b>Panorama Left-Right</b>	See <a href="#">page 37</a> .
<b>Panorama Right-Left</b>	See <a href="#">page 37</a> .
<b>Digital Image Stabilization</b>	Reducing blur caused by camera shake or subject motion.
<b>Sport</b>	Subjects that are in motion.
<b>Landscape</b>	Distant scenes.
<b>Close-up</b>	Close range. Use available light instead of flash, if possible.
<b>Night Portrait</b>	Reduces red eye of people in night scenes or low-light conditions.
<b>Night Landscape</b>	Distant scenery at night. Flash does not fire.
<b>Snow</b>	Bright snow scenes.
<b>Beach</b>	Bright beach scenes.
<b>Text</b>	Documents. Place the camera on a steady surface or tripod.
<b>Fireworks</b>	Fireworks. Place the camera on a steady surface or tripod.
<b>Flower</b>	Close-ups of flowers or other small subjects in bright light.

<b>SCN mode</b>	<b>For</b>
<b>Manner/ Museum</b>	Quiet occasions, like a wedding or lecture. Flash and sound are disabled. Place the camera on steady surface or tripod.
<b>Self- Portrait</b>	Close-ups of yourself. Assures proper focus and minimizes red eye.
<b>High ISO</b>	People indoors, in low-light scenes.
<b>Children</b>	Action pictures of children in bright light.
<b>Backlight</b>	Subjects that are in shadow or "backlit" (when light is behind the subject).
<b>Panning Shot</b>	Shooting a fast-moving subject. The background gives the sense of movement, while the subject appears still.
<b>Candle Light</b>	Subjects illuminated by candle light.
<b>Sunset</b>	Subjects at dusk.
<b>Custom</b>	Choosing your own settings.

## Using camera Help

To better understand each menu option, use camera Help.  
Highlight a menu choice, then press the Zoom telephoto (T) button.

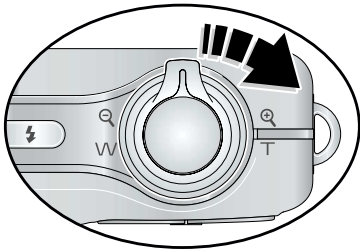

**T** Turn on Help

▲/▼ Scroll up/down

**OK** Turn off Help

## Understanding the picture-taking icons

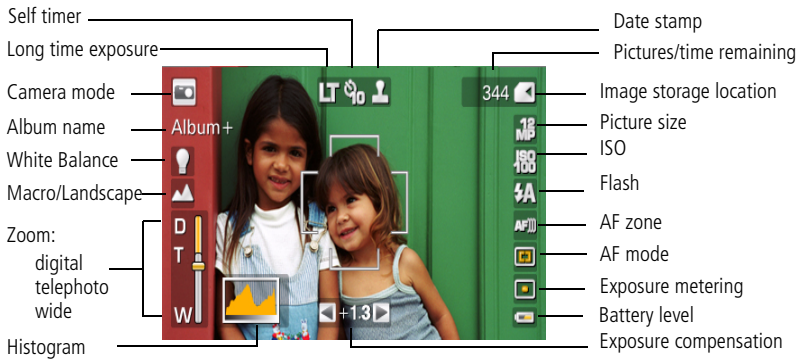

# 3

## Working with pictures/videos

### Reviewing pictures/videos



- 1 Press the Review button.
- 2 Press ◀/▶ for previous/next picture/video.

### Magnifying a picture

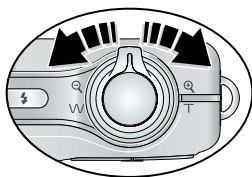

- 1 Press T to magnify 1X–8X.
- 2 Press ▲/▼ ◀/▶ to view other parts of a picture.
- 3 Press OK to return to 1X.

### Playing a video

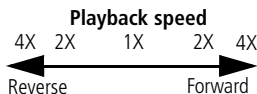

- Press ▼ to play a video. Press OK to pause/unpause. During playback:
- Press ▲/▼ to adjust the volume.
  - Press ▶ to play at 2X speed; press again for 4X.
  - Press ◀ to reverse at 2X speed; press again for 4X.
  - Press and hold ◀/▶ for 4 seconds to jump to a bookmark (see [page 21](#)).

## Deleting pictures/videos

- 1 Press the Review button.
- 2 Press ◀/▶ for previous/next picture/video.
- 3 Press the Delete button.
- 4 Follow the screen prompts.

NOTE: To delete protected pictures/videos, remove protection before deleting. (See [Protecting pictures/videos from deletion](#).)

## Using the undo delete feature

If you accidentally delete a picture/video, you may be able to use Undo Delete to retrieve it. This feature is only available immediately after you delete a picture/video.

## Protecting pictures/videos from deletion

- 1 Press the Review button.
- 2 Press ◀/▶ for previous/next picture/video.
- 3 Press the Menu button.
- 4 Press ▲/▼ to highlight Protect, then press the OK button.

*The picture/video is protected and cannot be deleted. The Protect icon  appears with the protected picture/video.*







- Press the Menu button to exit the menu.





### CAUTION:

**Formatting internal memory or an SD or MMC card deletes all (including protected) pictures/videos. (Formatting internal memory also deletes email addresses, album names, and favorites. To restore them, see EasyShare software Help.)**

## Using the menu button in review

- 1 Press the Review button, then the Menu button.
- 2 Press   to highlight a tab:
  -  **Review** to view pictures/videos
  -  **Edit** to edit pictures/videos
  -  **Setup** for other camera settings (see page 34)
- 3 Press   to highlight a setting, then press the OK button.
- 4 Highlight an option, then press the OK button.

 Options	
<b>View By</b>	See <a href="#">page 25</a>
<b>Album</b>	See <a href="#">page 43</a>
<b>Slide Show</b>	See <a href="#">page 22</a>
<b>Multimedia Slide Show</b>	See <a href="#">page 23</a>
<b>Multi-up</b>	See <a href="#">page 25</a>
<b>Copy To</b>	See <a href="#">page 27</a>
<b>Protect/Unprotect</b>	See <a href="#">page 15</a>
<b>Select/Deselect All</b>	See <a href="#">page 26</a>

 Options		
<b>Pictures</b>	<b>Perfect Touch tech.</b>	See <a href="#">page 18</a>
	<b>Crop</b>	See <a href="#">page 17</a>
	<b>Sound Tag</b>	See <a href="#">page 17</a>
<b>Videos</b>	<b>Make Picture</b>	See <a href="#">page 19</a>
	<b>Trim</b>	See <a href="#">page 19</a>
	<b>Action Print</b>	See <a href="#">page 20</a>
	<b>Bookmark</b>	See <a href="#">page 21</a>

## Cropping pictures

You can crop a picture so that only the desired portion of the picture remains.

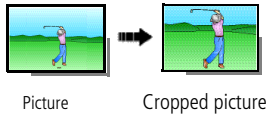

- 1 Press the Review button, then ◀/▶ to find a picture to crop.
  - 2 Press the Menu button, then ◀/▶ to highlight the Edit  tab. Press ▲/▼ to highlight Crop, then press the OK button.
  - 3 Press Telephoto (T) to zoom in or ◀/▶▲/▼ to move the crop box. Press the OK button.
  - 4 Follow the screen prompts.
 

*The picture is cropped. (The original is saved.) Cropped pictures cannot be cropped again on the camera.*
- Press the Menu button to exit the menu.

## Adding sound tags

You can record a voice or sound (up to 1 minute long) to a picture.

NOTE: Only one sound tag can be added to each picture (not to videos).

### Recording a sound tag

- 1 Press the Review button, then ◀/▶ to find a picture.
- 2 Press the Menu button, then ◀/▶ to highlight the Edit  tab.
- 3 Press ▲/▼ to highlight Sound Tag. Press the OK button.
- 4 Highlight Record, then press OK.
- 5 Follow the screen prompts.
 

*The sound tag is applied to your picture.*

■ Press the Menu button to exit the menu.

## Playing a sound tag

- 1 Press the Review button, then ◀/▶ to find a  tagged picture.
- 2 Press ▼ to play the sound tag.
- 3 Press ▲/▼ to adjust the volume.
- 4 Press OK to stop playback.

## Using Kodak Perfect Touch technology

Kodak Perfect Touch technology helps ensure better, brighter pictures.

- 1 Press the Review button.
- 2 Press ◀/▶ for previous/next picture.
- 3 Press the Menu button, then ◀/▶ to highlight the Edit  tab. Highlight Perfect Touch tech, then press the OK button.

*The enhancement is previewed. Press ◀/▶ to view other parts of the picture.*

- 4 Press the OK button. Follow the screen prompts to replace the original picture or to save the enhanced picture as a new one.

*Enhanced pictures cannot be enhanced again on the camera. Kodak Perfect Touch technology can only be used with pictures, not video.*

- Press the Menu button to exit the menu.





## Editing videos

You can do incredible things with your videos!

### Making a picture from a video

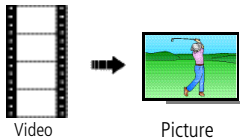
You can choose a single frame from a video, then make a picture suitable for a 4 x 6-inch (10 x 15 cm) print.



- 1 Press the Review button, then ◀/▶ to find a video.
- 2 Press the Menu button, then ◀/▶ to highlight the Edit  tab. Highlight Make Picture, then press the OK button.
- 3 Follow the screen prompts.  
*A picture is created. (The original video is saved.)*
  - Press the Menu button to exit the menu.

### Trimming a video

You can trim an unwanted start or end from a video, saving only the desired portion.

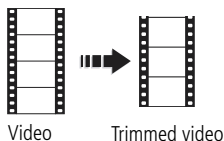

- 1 Press the Review button, then ◀/▶ to find a video.
- 2 Press the Menu button, then ◀/▶ to highlight the Edit  tab. Highlight Trim, then press the OK button.
- 3 Follow the screen prompts.  
*The video is trimmed. (You can save it as a new video or replace the original.)*
  - Press the Menu button to exit the menu.

## Making a video action print

From a video, you can make a 4-, 9-, or 16-up picture, suitable for a 4 x 6-inch (10 x 15 cm) print.

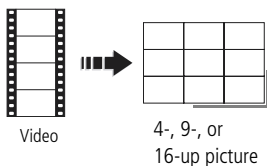

- 1 Press the Review button, then ◀/▶ to find a video.
- 2 Press the Menu button, then ◀/▶ to highlight the Edit  tab. Highlight Action Print, then press the OK button.
- 3 Highlight an option, then press the OK button.

**Auto:** The camera includes the first and last frames, then 2, 7, or 14 equally spaced frames.

**Manual:** Choose first and last frames; the camera chooses 2, 7, or 14 spaced frames.

**Full Manual:** Choose 4, 9, or 16 frames.

**Use Bookmarks:** The camera uses bookmarked frames.

*A 4-, 9-, or 16-up picture is created. If you have less than 4 or 9 bookmarks, equally spaced video frames are used.*

- Press the Menu button to exit the menu.

## Using video bookmarks

You can set bookmarks at interesting places in your video, then jump from one bookmark to another.

### Setting bookmarks

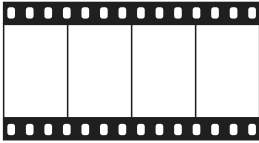

- 1 Press the Review button, then ◀/▶ to find a video.
- 2 Press the Menu button, then ◀/▶ to highlight the Edit  tab. Highlight Bookmark, then press the OK button.
- 3 Press ▼ to add bookmarks. When finished adding up to 9 bookmarks, press ▲ .
  - Press the Menu button to exit the menu.

### Using bookmarks

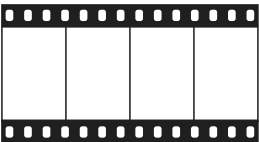





- 1 Press the Review button, then ◀/▶ to find a video.
- 2 Press ▼ to play the video. To jump to the first bookmark, press and hold ◀/▶ for 4 seconds while the video is playing.
  - After you jump to a bookmark, press ◀/▶ to jump to other bookmarks.
  - To view all bookmarked video frames, press the Zoom wide angle (W) button. To return to normal view, press the telephoto (T) button.

## Running a slide show





Use Slide Show to display your pictures/videos on the LCD.

NOTE: If you have a Kodak EasyShare HDTV dock, see its Getting Started Guide. If you have an EasyShare photo frame dock 2, see [page 25](#).

- 1 Press the Review button.
- 2 Press the Menu button, then   to highlight the Review  tab. Highlight Slide Show, then press the OK button.
- 3 Press / to highlight Begin Show, then press the OK button.  
*Each picture/video is displayed once. To interrupt the Slide Show, press the OK button.*







## Changing the slide show display interval

The default interval setting displays each picture for 5 seconds. You can set the display interval from 3–60 seconds.

- 1 On the Slide Show menu, press / to highlight Interval, then press OK.
- 2 Select a display interval.  
To scroll through the seconds quickly, press and hold /.
- 3 Press the OK button.  
*The interval setting remains until you change it.*

## Running a continuous slide show loop

When you turn on Loop, the slide show is continuously repeated.

- 1 On the Slide Show menu, press / to highlight Loop, then press the OK button.
- 2 Press / to highlight On, then press the OK button.
- 3 Press / to highlight Begin Show, then press the OK button.  
*The slide show repeats until you press the OK button or until battery power is exhausted. The Loop feature remains until you change it.*

## Choosing a slide show transition

Choose how the slide show transitions from one picture to another.

- 1 On the Slide Show menu, press ▲/▼ to highlight Transition, then press the OK button.
- 2 Press ▲/▼ to select a transition, then press the OK button.

## Running a multimedia slide show

Multimedia Slide Show is similar to Slide Show, but also offers music and visual effects. For a true HDTV experience on your television, dock your camera on the Kodak EasyShare HDTV dock. To purchase accessories, visit [www.kodak.com/go/v1233accessories](http://www.kodak.com/go/v1233accessories).

- 1 First, select 2–20 pictures. (To select multiple pictures, see [page 26](#).)
- 2 Press the Review button.
- 3 Press the Menu button, then ◀/▶ to highlight the Review ► tab. Highlight Multimedia Slide Show, then press the OK button.
- 4 Press ▲/▼ to highlight a choice from the menu below, then press the OK button.
  - Begin Show
  - Music
  - Effect
  - Play Order

Each picture/video is displayed once. To interrupt the slide show, press the OK button. After the slide show plays, you may save or modify it.

## Displaying pictures/videos on a television

You can display pictures/videos on a television, computer monitor, or any device equipped with a video input. To connect the camera to a television, use an A/V cable (may be sold separately) and the USB / A/V adapter.

For a true HDTV experience on your television, dock your camera on the Kodak EasyShare HDTV dock. To purchase accessories, visit [www.kodak.com/go/v1233accessories](http://www.kodak.com/go/v1233accessories).

NOTE: Ensure that the Video Out setting (NTSC or PAL) is correct ([see page 36](#)). The slide show stops if you connect or disconnect the cable while the slide show is running. (Image quality on a television screen may not be as good as on a computer monitor or when printed.)

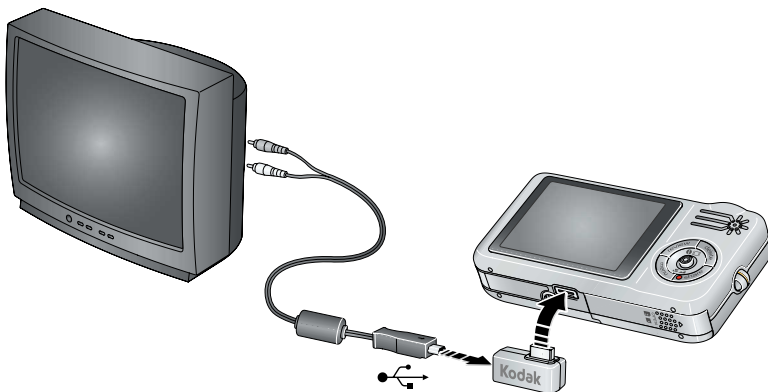

## Running a slide show with the photo frame dock 2

Your package may include an EasyShare photo frame dock 2. (To purchase accessories, visit [www.kodak.com/go/v1233accessories](http://www.kodak.com/go/v1233accessories).)

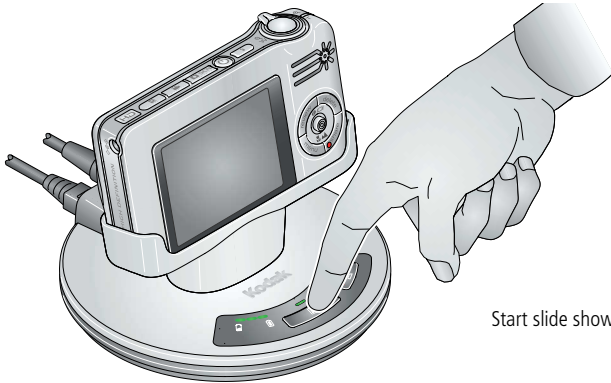

Start slide show.

## Viewing pictures/videos in different ways

### Viewing as thumbnails (multi-up)

- 1 Press the Review button.
- 2 Press W to change from single-picture view to multi-up thumbnails.
- 3 Press T to return to single-picture view.
  - To select multiple pictures/videos, see [page 26](#).
  - Press the Review button to exit Review.

## Viewing by date or by album

- 1 Press the Review button.
- 2 Press the Menu button, then **◀/▶** to highlight the Review **▶** tab.
- 3 Press **▲/▼** to highlight View By, then press the OK button. Highlight All, Date, Album, or Image Storage, then press the OK button.
  - Press **▲/▼** **◀/▶** to highlight a date, album, or image storage, then press the T button. To return to the list, press the W button.
  - Press the Review button to exit Review.
  - For more about albums, see [page 43](#).

## Viewing picture/video information

- 1 Press the Review button.
- 2 Repeatedly press the Info/Display **i** **|** **□** button to turn on/off status icons, histogram, and picture/video info.
  - Press the Review button to exit Review.

## Selecting multiple pictures/videos

Use the multi-select feature when you have two or more pictures/videos to print, transfer, delete, etc. (Multi-select is used most effectively in Multi-Up mode, [page 25](#).)

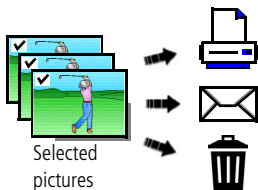

- 1 Press the Review button, then **◀/▶** to find a picture/video.
- 2 Press the OK button to select pictures/videos.





*A check mark appears on the picture. You can now print, transfer, delete, etc. the selected pictures. You can press OK a second time to remove a check mark.*



## Copying pictures/videos

You can copy pictures/videos from a card to internal memory or from internal memory to a card.

### Copy pictures/videos:

- 1 Press the Review button.
- 2 Press the Menu button, then   to highlight the Review  tab.
- 3 Press / to highlight Copy To, then press the OK button. Highlight Memory Card or Internal Memory, then press the OK button.

NOTE: Pictures/videos are copied, not moved. To remove pictures/videos from the original location after copying, delete them (see [page 15](#)). Tags that you applied for print, email, and favorites are not copied. Protection settings are not copied. To apply protection to a picture/video, see [page 15](#).

## Understanding the blur warning icons

If the feature is turned on (see [page 33](#)), a blur alert icon  is displayed during picture review and quickview.

**Green**—Picture is sharp enough for an acceptable 4 x 6-inch (10 x 15 cm) print.

**Yellow**—Picture may be sharp enough for an acceptable 4 x 6-inch (10 x 15 cm) print or sharpness is not determined. (You may want to view on a computer monitor before printing.)

**Red**—Picture is not sharp enough for an acceptable 4 x 6-inch (10 x 15 cm) print.

**White**—Print sharpness is not determined.

## Understanding the review icons

### Pictures

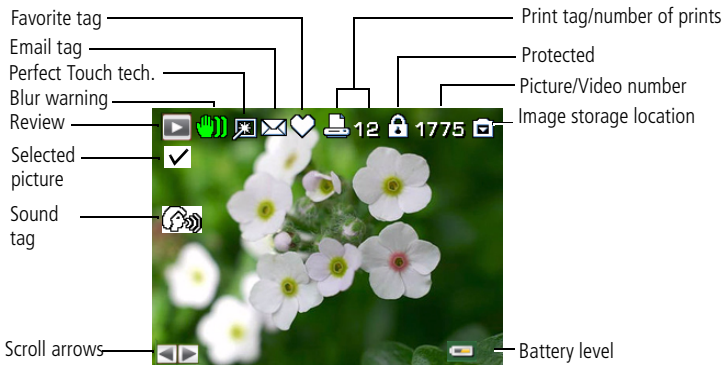

### Videos











# 4

## Doing more with your camera





### Using the menu button to change settings





You can change settings to get the best results from your camera.





NOTE: Some settings remain until you change them; others, until you change modes or turn off the camera.  
Some modes offer limited settings.

- 1 Press the Menu button.
- 2 Press   to highlight a tab:
  -  **Capture** for the most common picture-taking settings
  -  **Capture plus** for other picture-taking settings
  -  **Video** for video-taking settings
  -  **Setup** for other camera settings
- 3 Press   to highlight a setting, then press the OK button.
- 4 Highlight an option, then press the OK button.





### Using the capture tab





Press Menu,  ,  ,  ,  , and OK to access settings	 Options
<b>Self-timer</b> Choose a self-timer setting.	See <a href="#">page 8</a> .

Press Menu,  ,  ,  ,  , and OK to access settings	 Options
<p><b>Burst</b></p> <p>Camera takes up to 3 pictures while the Shutter button is pressed.</p> <p>Capture an event, such as a person swinging a golf club.</p>	<p><b>On</b></p> <p><b>Off (default)</b></p> <p>Press the Shutter button <b>halfway</b> to focus and set exposure. Press the Shutter button <b>completely down and hold it</b> to take pictures.</p> <p><i>The camera stops taking pictures when you release the Shutter button, when the pictures are taken, or when no storage space remains.</i></p>
<p><b>Picture Size</b></p> <p>Choose a picture resolution. For recommended print sizes, visit <a href="http://www.kodak.com/go/printsizes">www.kodak.com/go/printsizes</a></p>	<p><b>12.0 MP (4:3) (default)</b>—Highest resolution; largest file size.</p> <p><b>10.7 MP (3:2)</b>—For printing on EasyShare printer docks and photo printers.</p> <p><b>9 MP (16:9)</b>—HDTV format.</p> <p><b>6 MP (4:3)</b>—Medium resolution and file size.</p> <p><b>3.1 MP (4:3)</b>—Small to medium file size.</p> <p><b>2.2 MP (3:2)</b>—For printing on EasyShare printer docks and photo printers (at a lower resolution than 10.7 MP).</p> <p><b>2.1 MP (16:9)</b>—HDTV format.</p> <p><b>1.2 MP (4:3)</b>—Email, Internet, or to conserve space.</p>
<p><b>Long Time Exposure</b></p> <p>Choose how long the shutter stays open.</p>	<p><b>None (default)</b></p> <p><b>0.5, 1.0, 2.0, 4.0, or 8.0</b> seconds</p>





Press Menu,  ,  ,  ,  , and OK to access settings	 Options
<p><b>Color Mode</b> Choose color tones. Unavailable in Video mode.</p>	<p><b>High Color</b> <b>Natural Color (default)</b> <b>Low Color</b> <b>Black &amp; White</b> <b>Sepia</b>—for a reddish-brown, antique look. NOTE: EasyShare software also lets you change a color picture to black-and-white or sepia.</p>
<p><b>AF Control</b> Choose an auto-focus setting.</p>	<p><b>Continuous AF (default for video)</b>—because the camera is always focusing, there is no need to press the Shutter button halfway down to focus. <b>Single AF (default for pictures)</b>—uses TTL-AF (through-the-lens auto focus) when the Shutter button is pressed halfway down.</p>
<p><b>Date Stamp</b> Imprint the date on pictures. Not available on panoramic pictures.</p>	<p>Choose a date option, or turn off the feature. (Default is off.)</p>

## Using the capture plus tab

<b>Press Menu, , , , , and OK to access settings</b>	 <b>Options</b>
<b>White Balance</b> Choose your lighting condition. Available in Auto and SCN-Custom mode.	<b>Auto (default)</b> —automatically corrects white balance. Ideal for general picture taking. <b>Daylight</b> —for pictures in natural lighting. <b>Tungsten</b> —corrects the orange cast of household light bulbs. Ideal for indoor pictures under tungsten or halogen lighting without flash. <b>Fluorescent</b> —corrects the green cast of fluorescent lighting. Ideal for indoor pictures under fluorescent lighting without flash. <b>Open Shade</b> —for pictures in shade in natural lighting.
<b>Face Detect Capture</b> Choose if faces get focus priority.	<b>On (default)</b> —In Auto mode (and in SCN modes designed for pictures of people), the camera attempts to focus on faces. <b>Off</b>
<b>Exposure Metering</b> Evaluate light levels at specific areas of a scene.	<b>Multi-Pattern (default)</b> —evaluates lighting conditions throughout the image to give an optimum picture exposure. Ideal for general picture taking. <b>Center-Weight</b> —evaluates the lighting conditions of the subject centered in the lens. Ideal for backlit subjects. <b>Center-Spot</b> —similar to Center-weight, except the metering is concentrated on a smaller area of the subject centered in the lens. Ideal when you need an exact exposure of a specific area in the picture.
<b>AF Zone</b> Select a large or concentrated area of focus.	<b>Multi-Zone (default)</b> —evaluates 5 zones to give an even picture focus. Ideal for general picture taking. <b>Center-Zone</b> —evaluates the small area centered in the lens. Ideal when you need precise focus.





Press Menu,  ,  ,  ,  , and OK to access settings	 Options
<b>ISO Speed</b> Control the sensitivity of the camera sensor.	<b>Auto (default)</b> <b>ISO 64, 100, 200, 400, 800, 1600, 3200</b> (ISO 3200 available for picture sizes of 3.1 MP or less.)
<b>Red Eye Preflash</b> Choose whether a preflash fires when the flash is in Red Eye mode.	<b>On (default)</b> —red eye flash fires before the picture is taken. <b>Off</b> —red eye flash does not fire. NOTE: The camera automatically corrects red eye, even if the Red Eye Preflash is set to Off.
<b>Sharpness</b> Control picture sharpness.	<b>High</b> <b>Normal (default)</b> <b>Low</b>
<b>Blur Warning</b> See <a href="#">page 27</a> .	<b>On (default)</b> <b>Off</b>
<b>Reset to Default</b> Available only in SCN-Custom mode.	All picture-taking settings return to their default.
<b>Maintain Settings</b> Choose which settings are saved, even after the camera is turned off. Available only in Auto mode.	<b>Flash</b> <b>White Balance</b> <b>ISO Speed</b> <b>Color Mode</b> <b>Sharpness</b> <b>Exposure Metering</b> <b>AF Zone</b>

## Using the video tab





<p>Press Menu, , , , , and OK to access settings</p>	 <b>Options</b>
<p><b>Self-timer</b> Choose a self-timer setting.</p>	<p>See <a href="#">page 8</a>.</p>
<p><b>Video Size</b> Choose a video resolution.</p>	<p><b>1280 x 720 (HD720p) HQ</b>—HDTV format; uses the least compression, gives the highest video quality.  <b>1280 x 720 (HD720p) (default)</b>—HDTV format; uses compression to save space.  <b>640 x 480 HQ</b>—medium quality and file size.  <b>640 x 480</b>—medium quality and file size; uses compression to save space.  <b>320 x 240</b>—lowest quality; smallest file size.</p>
<p><b>AF Control</b> Choose an auto-focus setting.</p>	<p><b>Continuous AF (default for video)</b>—because the camera is always focusing, there is no need to press the Shutter button halfway down to focus.  <b>Single AF (default for pictures)</b>—uses TTL-AF (through-the-lens auto focus) when the Shutter button is pressed halfway down.</p>
<p><b>Image Stabilizer</b> Improve video stability.</p>	<p><b>On (default)</b> <b>Off</b></p>







## Customizing your camera

Use Setup to customize your camera.

<p>Press Menu, ,  to highlight Setup, then ,  to access settings</p>	 <b>Options</b>
<p><b>LCD Brightness</b> Choose LCD brightness.</p>	<p><b>Power Save</b> <b>High Power (default)</b></p>



Press Menu,   to highlight Setup, then   to access settings	 Options
<b>LCD Dimmer</b> Choose inactivity time until LCD dims.	<b>30 seconds</b> <b>20 seconds</b> <b>10 seconds (default)</b> <b>Off (no dimming)</b>
<b>Image Storage</b> Choose a storage location for pictures/videos.	<b>Auto (default)</b> —the camera uses the card if one is in the camera. If not, the camera uses internal memory. <b>Internal Memory</b> —the camera always uses internal memory, even if a card is installed.
<b>Set Album</b> Choose Album names. You can apply different Set Album choices to videos and to pictures.	<b>Clear All</b> —selected album settings are cancelled. Pre-select album names before you take pictures/videos. Then, all the pictures/videos you take are tagged with those album names. See <a href="#">page 44</a> .
<b>Orientation Sensor</b> Orient pictures/videos so that they are displayed with the correct side up.	<b>On (default for pictures)</b> <b>Off (default for videos)</b>
<b>Camera Sounds</b> Choose sound effects.	<b>Theme</b> —applies the same sound effect set to all functions. <b>Individual</b> —choose a sound for each function.
<b>Sound Volume</b>	<b>Off</b> <b>High</b> <b>Medium (default)</b> <b>Low</b>
<b>Date &amp; Time</b>	Set date and time.
<b>Digital Zoom</b> Turn digital zoom on or off.	<b>On (default)</b> <b>Off</b>

Press Menu,   to highlight Setup, then   to access settings	 Options
<p><b>Auto Power Off</b> Choose inactivity time until camera turns off.</p>	<p><b>10 minutes</b> <b>5 minutes</b> <b>3 minutes (default)</b> <b>1 minute</b></p>
<p><b>Video Out</b> Choose the regional setting that lets you connect the camera to a television or other external device.</p>	<p><b>NTSC (default)</b>—used in North America and Japan; most common format. <b>PAL</b>—used in Europe and China.</p>
<p><b>Photo Frame</b> Choose EasyShare photo frame dock 2 slide show settings.</p>	<p><b>Interval</b> (between slide show frames) <b>Loop</b> (On/Off, for slide show) <b>Transition</b> (between slide show frames) <b>Source</b> (Auto/Internal/Favorites) <b>Run Time</b> (for slide show)</p>
<p><b>Language</b></p>	<p>Choose your language.</p>
<p><b>Format</b></p> <p> <b>CAUTION:</b> <b>Formatting deletes all pictures/videos, including those that are protected. Removing a card during formatting may damage the card.</b></p>	<p><b>Memory Card</b>—deletes everything on the card; formats the card. <b>Cancel</b>—exits without making a change. <b>Internal Memory</b>—deletes everything in internal memory including email addresses, album names, and favorites; formats the internal memory.</p>
<p><b>Reset Camera</b> Available in all modes except SCN-Custom.</p>	<p>Reset settings to their default.</p>
<p><b>Feature Demos</b></p>	<p>View short videos describing new features.</p>

## Taking panoramic pictures

Use panorama to “stitch” up to 3 pictures into a panoramic scene.

NOTE: For best results, use a tripod. Only the panoramic picture is saved; individual pictures are not. (Picture size is set to 6 MP. Exposure and white balance are set with the first picture. The flash is set to Off.)

- 1 Press the Auto/SCN button until the Scene icons appear on the LCD.
- 2 Press **◀/▶** to highlight Panorama Left-Right or Panorama Right-Left (depending on the direction you want to pan), then press the OK button.
- 3 Take the first picture.  
*After a quickview, the LCD displays the liveview and an “overlay” from the first picture.*
- 4 Compose the second picture. Make the overlay from the first picture cover the same portion in the new picture. (You can press the Delete button to re-take a picture.)
- 5 If you are taking only 2 pictures, press the OK button to stitch them together.  
*After you take 3 pictures, the pictures are automatically stitched together.*

Take 2 or 3 pictures.



Get 1 panoramic picture.



NOTE: To use the self-timer 10-second or 2-second setting, see [page 8](#).

## Using exposure compensation to adjust picture brightness

Before you take a picture, you can adjust exposure compensation to make pictures darker or lighter.

- Press ◀ to decrease exposure compensation.
- Press ▶ to increase exposure compensation.

*The exposure compensation level is shown on the LCD; the LCD gets brighter or dimmer.*

## Using the histogram to view picture brightness

Use the histogram to evaluate the distribution of light before or after you take a picture. If the peak is to the right of the graph, the subject is bright; if it's to the left, the subject is dark. Optimal exposure is achieved when the peak is in the middle of the histogram. The flash may affect a picture's light and shadow.



To turn on the histogram in Capture mode or in Review, press the Info/Display **i**  button until the histogram appears.

## Using the framing grid to compose a picture

The framing grid divides the LCD into thirds—vertically and horizontally. This is helpful if, for example, you want to balance a picture between water, earth, and sky.



To turn on the framing grid in Auto/SCN mode, press the Info/Display **i**  button until the grid appears.

## Sharing your pictures

Press the Share button to tag your pictures/videos. When they are transferred to your computer, you can share them.

### Tagging pictures for printing

- 1 Press the Share button. Press ◀/▶ to find a picture.
- 2 Press ▲/▼ to highlight Print, then press the OK button.\*
- 3 Press ▲/▼ to select the number of copies (0–99). Zero removes the tag.  
*The Print icon  appears in the status area. The default quantity is one.*
- 4 **Optional:** You can apply a print quantity to other pictures. Press ◀/▶ to find a picture. Keep the print quantity as is, or press ▲/▼ to change it. Repeat this step until the desired print quantity is applied to the pictures.
- 5 Press OK. Press the Share button to exit the menu.

\* To tag all pictures in the storage location, highlight Print All, press OK, then indicate the number of copies. Print All is not available in quickview. To remove print tagging for all pictures in the storage location, highlight Cancel Prints, then press OK.

### Printing tagged pictures

When you transfer the tagged pictures to your computer, the EasyShare software print screen opens. For details on printing, see Help in EasyShare software.

For more information on printing from your computer, printer dock, PictBridge enabled printer, or card, see [page 47](#).



NOTE: For the best 4 x 6 in. (10 x 15 cm) prints, use the 3:2 picture size ([see page 30](#)).

### Tagging pictures/videos for emailing

#### First—on your computer

Use Kodak EasyShare software to create an email address book on your computer. Then, copy up to 32 email addresses to the camera's internal memory. For details, see Help in EasyShare software.

## Second—tag pictures/videos on your camera

- 1 Press the Share button. Press ◀/▶ to find a picture/video.
- 2 Press ▲/▼ to highlight Email, then press the OK button.  
*The Email icon  appears in the status area.*
- 3 Press ▲/▼ to highlight an email address, then press the OK button.  
To tag other pictures/videos with the same address, press ◀/▶ to scroll through them. When the picture you want is displayed, press the OK button.  
To send the pictures/videos to more than one address, repeat step 3.  
*Selected addresses are checked.*
- 4 To remove a selection, highlight a checked address and press the OK button. To remove all email selections, highlight Clear All.
- 5 Press ▲/▼ to highlight Exit, then press the OK button.  
*The Email icon  appears in the status area.*
- 6 Press the Share button to exit the menu.

NOTE: To add an email address, use the Add Email menu choice. Then use the on-camera keyboard.

### Third—transfer and email

When you transfer the tagged pictures/videos to your computer, EasyShare software prompts you to send the pictures/videos. For details, see Help in EasyShare software.

### Tagging pictures as favorites

Want to keep copies of your favorite pictures on your camera?

Start with the Share button!

<b>1. Tag pictures as favorites</b>	<ol style="list-style-type: none"> <li>1 Press the Share button. Press ◀/▶ to find a picture.</li> <li>2 Press ▲/▼ to highlight Favorite, then press the OK button. <i>The Favorite icon ♥ appears in the status area. To remove the tag, press the OK button again.</i></li> </ol>
<b>2. View favorites on your camera</b>	<ol style="list-style-type: none"> <li>1 Press the Favorites  button.</li> <li>2 Press ◀/▶ to view favorites.</li> </ol>

NOTE: Videos tagged as favorites remain in the Favorites folder in EasyShare software. For details, see Help in EasyShare software.

## Preventing camera favorites from synchronizing with the software

If you don't want to use the favorites feature:

- 1 Open EasyShare software.
- 2 From the Tools menu, select Cameras/Viewers > Sync and Transfer Manager.
- 3 Highlight your camera, then click Camera Favorites Album Properties.  
NOTE: If your camera model is not visible, use the USB cable to connect your camera to the computer.
- 4 Drag the Internal Memory slider to 0%, then click OK.
- 5 Close the Sync and Transfer Manager window.



*Camera favorites will no longer synchronize with EasyShare software.*

*To turn on the sync feature, select Yes, synchronize with my software.*

*To delete favorites from your camera, press the Delete button while in Favorites mode.*



## Optional settings

In Favorites mode, press the Menu button to access optional settings.

	Slide Show ( <a href="#">page 22</a> )
	Multi-Up ( <a href="#">page 25</a> )

NOTE: Pictures taken at the 3:2 picture size are displayed at a 3:2 aspect ratio with a black bar at the top and bottom of the screen.

## Printing and emailing favorites

- 1 Press the Favorites  button. Press   to find a picture.
- 2 Press the Share button.
- 3 Highlight Print or Email, then press the OK button.

NOTE: Favorites that were taken on this camera (not imported from another source) are good for prints up to 4 x 6 in. (10 x 15 cm).



## Tagging pictures/videos for albums

Use the Album feature to tag the pictures/videos in your camera with album names.

### First—on your computer

Use EasyShare software to create album names on your computer, then copy up to 32 album names to the camera's internal memory.

### Second—on your camera

- 1 Press the Review button, then find the picture/video.
- 2 Press the Menu button.
- 3 Press  $\blacktriangle/\blacktriangledown$  to highlight Album, then press the OK button.
- 4 Press  $\blacktriangle/\blacktriangledown$  to highlight an album name, then press the OK button.

To add other pictures to the same album, press  $\blacktriangle/\blacktriangleright$  to scroll through the pictures. When the picture you want is displayed, press the OK button.

To add the pictures to more than one album, repeat step 4 for each album.

*The album name appears with the picture. A plus (+) after the album name means the picture was added to more than one album.*

To remove a selection, highlight an album name and press the OK button. To remove all album selections, select Clear All.

### Third—transfer to your computer

When you transfer the tagged pictures/videos to your computer, EasyShare software opens and categorizes your pictures/videos in the appropriate album.

NOTE: To add an album, use the Add Album menu choice. Then use the on-camera keyboard.







## Pre-tagging for album names

Use the Set Album feature to pre-select album names before you take pictures/videos. Then, all the pictures/videos you take are tagged with those album names.

### First—on your computer

Use the EasyShare software to create album names on your computer. The next time you connect the camera to the computer, up to 32 album names are copied to the camera's internal memory.

### Second—on your camera

- 1 In any mode, press the Menu button.
- 2 Press   to highlight the Setup  tab.
- 3 Press   to highlight Set Album, then press the OK button.
- 4 Press   to highlight an album name, then press the OK button.
- 5 Highlight Exit, then press the OK button.
- 6 Press the Menu button to exit the menu.

*Your selections are saved. Your album selection is displayed on the LCD. A plus (+) after the album name means more than one album is selected.*

### Third—transfer to your computer

When you transfer the tagged pictures/videos to your computer, EasyShare software opens and categorizes your pictures/videos in the appropriate album. For details, see Help in EasyShare software.

# 5

## Transferring and printing pictures



### CAUTION:

Before connecting any cables, install the software that was included with your camera. Failure to do so may cause the software to load incorrectly.

### Installing the software

- 1 Close all open software applications before starting the installation.

NOTE: If running Windows OS and installing EasyShare software from the Kodak Web site, do not close the WinZip application. If prompted, allow EasyShare software to access the Internet.

- 2 Place the Kodak EasyShare software CD into the CD-ROM drive.

- 3 Load the software:

**Windows OS**—if the install window does not appear, choose Run from the Start menu and type **d:\setup.exe** where **d** is the drive letter that contains the CD.

**Mac OS X**—double-click the CD icon on the desktop, then click the Install icon.

- 4 Follow the on-screen instructions to install the software.

NOTE: When prompted, register your camera and software. Registering lets you sign up for information that keeps your system up-to-date. To register later, visit [www.kodak.com/go/register](http://www.kodak.com/go/register).

- 5 If prompted, restart the computer.

For information on the software applications included on the Kodak EasyShare software CD, see Help in EasyShare software.

## Transferring pictures/videos

### Using the USB cable

If you do not have an EasyShare dock, use a Kodak USB cable, model U-8 and the USB / A/V adapter.

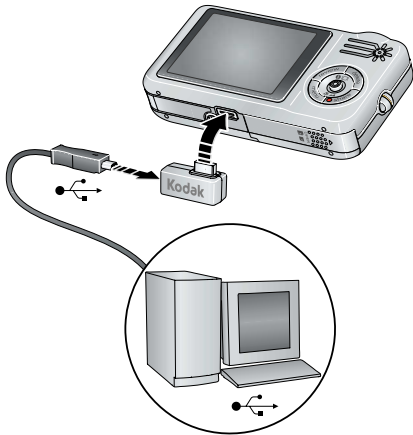

Connect, then turn on camera.

### Using the photo frame dock 2

If you have a Kodak EasyShare photo frame dock 2, use it to transfer pictures. (To purchase accessories, visit [www.kodak.com/go/v1233accessories](http://www.kodak.com/go/v1233accessories).)

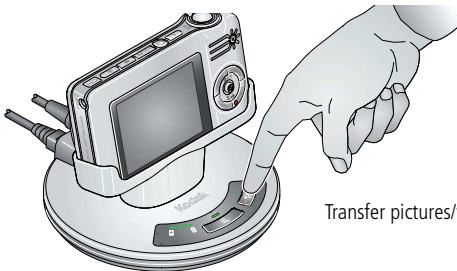

Transfer pictures/videos.

## Using other options

You can also use these Kodak products to transfer your pictures/videos:

- Kodak EasyShare camera dock, Kodak EasyShare printer dock (see [page 49](#))
- Kodak card readers

NOTE: To purchase accessories, visit [www.kodak.com/go/v1233accessories](http://www.kodak.com/go/v1233accessories).

Visit [www.kodak.com/go/howto](http://www.kodak.com/go/howto) for an online tutorial on connecting.

## Printing pictures

### Printing with a Kodak EasyShare printer dock

Dock your camera to the Kodak EasyShare printer dock and print with or without a computer. To purchase accessories, visit [www.kodak.com/go/v1233accessories](http://www.kodak.com/go/v1233accessories).

For dock compatibility, visit [www.kodak.com/go/dockcompatibility](http://www.kodak.com/go/dockcompatibility).

### Direct printing with a PictBridge enabled printer

Your camera is compatible with PictBridge technology, so you can print directly to PictBridge enabled printers. You need:

- Camera with fully charged battery
- PictBridge enabled printer
- USB cable
- USB / A/V adapter

## Connecting the camera to a PictBridge enabled printer

- 1 Turn off the camera and printer.
- 2 Connect the appropriate USB cable from the camera to the printer. (Use a USB / A/V adapter) See your printer user guide for details or [www.kodak.com/go/v1233accessories](http://www.kodak.com/go/v1233accessories) to order accessories.

## Printing from a PictBridge enabled printer

- 1 Turn on the printer. Turn on the camera.

*The PictBridge logo is displayed, followed by the current picture and menu. (If no pictures are found, a message is displayed.) If the menu interface turns off, press any button to redisplay it.*

- 2 Press ▲/▼ to highlight a printing option, then press the OK button.

**Current Picture**—Press ◀/▶ to choose a picture. Choose the number of copies.

**Tagged Pictures**—If your printer is capable, print pictures that you tagged for printing and choose a print size.

**Index Print**—Print thumbnails of all pictures. (This option requires one or more sheets of paper.) If the printer is capable, choose a print size.

**All Pictures**—Print all pictures in internal memory, on a card, or in Favorites. Choose the number of copies.

**Image Storage**—Access Internal/Card or Favorites.

NOTE: During direct printing, pictures are not permanently transferred or saved to the printer. To transfer pictures to your computer, see [page 46](#). In Favorites mode, the current favorite picture is displayed.

## Disconnecting the camera from a PictBridge enabled printer

- 1 Turn off the camera and printer.
- 2 Disconnect the USB cable from the camera and the printer.

## Using a printer that is not PictBridge enabled

After you transfer pictures from the camera to your computer, you can print them from EasyShare software. For details, see Help in EasyShare software.

## Ordering prints online

Kodak EasyShare Gallery ([www.kodakgallery.com](http://www.kodakgallery.com)) is one of the many online print services offered in EasyShare software. You can easily:

- Upload your pictures.
- Edit, enhance, and add borders to your pictures.
- Store pictures, and share them with family and friends.
- Order high-quality prints, photo greeting cards, frames, and albums—and have them delivered to your door.

## Printing from an optional SD or MMC card

- Automatically print tagged pictures when you insert your card into a printer with an SD/MMC card slot. See your printer user's guide for details.
- Make prints at an SD/MMC card-capable Kodak picture maker/picture kiosk. (Contact a location prior to visiting. Visit [www.kodak.com/go/picturemaker](http://www.kodak.com/go/picturemaker).)
- Take the card to your local photo retailer for professional printing.

## Dock compatibility for your camera

To see which EasyShare camera and printer docks are compatible with your camera, visit [www.kodak.com/go/dockcompatibility](http://www.kodak.com/go/dockcompatibility).

To purchase camera docks, printer docks, and other accessories, visit [www.kodak.com/go/v1233accessories](http://www.kodak.com/go/v1233accessories).

## 6

# Troubleshooting

## Camera problems

Status	Solution
Camera does not turn on	<ul style="list-style-type: none"> <li>■ Make sure the battery is charged and installed correctly (see <a href="#">page 1</a>).</li> <li>■ Turn the camera off, then on again.</li> </ul>
Camera does not turn off	
Camera buttons and controls do not function	
In Review, a blue or black screen is displayed instead of a picture	<ul style="list-style-type: none"> <li>■ Transfer <i>all</i> pictures to the computer (see <a href="#">page 45</a>).</li> <li>■ Take another picture.</li> </ul>
Pictures remaining number does not decrease after taking a picture	<ul style="list-style-type: none"> <li>■ Continue taking pictures. The camera is operating normally. (The camera estimates the number of pictures remaining after each picture is taken, based on picture size and content.)</li> </ul>
Flash does not fire	<ul style="list-style-type: none"> <li>■ Check the flash setting, and change as needed (see <a href="#">page 9</a>).</li> </ul> <p>NOTE: The flash does not fire in all modes.</p>
Memory card is almost or entirely full	<ul style="list-style-type: none"> <li>■ Transfer the pictures to the computer (see <a href="#">page 45</a>).</li> <li>■ Delete pictures from the card or insert a new card.</li> </ul>
The battery does not charge using USB charging	<ul style="list-style-type: none"> <li>■ See <a href="#">page 2</a> or visit <a href="http://www.kodak.com/go/USBcharging">www.kodak.com/go/USBcharging</a>.</li> </ul>



Status	Solution
Battery life is short	<ul style="list-style-type: none"> <li>■ Make sure the correct battery type is installed (see <a href="#">page 60</a>).</li> <li>■ Wipe the contacts with a clean, dry cloth before inserting a battery in the camera.</li> <li>■ Insert a new or charged battery (see <a href="#">page 1</a>).</li> </ul>
You cannot take a picture	<ul style="list-style-type: none"> <li>■ Turn the camera off, then on again.</li> <li>■ Depress the Shutter button all the way (see <a href="#">page 5</a>).</li> <li>■ Insert a new or charged battery (see <a href="#">page 1</a>).</li> <li>■ Memory is full. Transfer pictures to the computer (see <a href="#">page 45</a>), delete pictures (see <a href="#">page 15</a>), or insert another card.</li> </ul>
Error message appears on LCD	<ul style="list-style-type: none"> <li>■ Turn the camera off, then on again.</li> <li>■ Remove the memory card.</li> <li>■ Turn off the camera. Remove the battery. Wipe the contacts with a clean, dry cloth.</li> <li>■ Insert a new or charged battery.</li> <li>■ If the problem still exists, get help (see <a href="#">page 54</a>).</li> </ul>
Memory card not recognized or camera freezes with card	<ul style="list-style-type: none"> <li>■ Card may be corrupted. Format the card in the camera (see <a href="#">page 36</a>).</li> <li>■ Use another memory card.</li> </ul>
Cannot find the desired picture/video	<ul style="list-style-type: none"> <li>■ To view pictures on a card or in internal memory, see <a href="#">page 14</a>.</li> </ul>

### Computer/connectivity problems

Status	Solution
Pictures do not transfer to computer	<ul style="list-style-type: none"> <li>■ See Help in EasyShare software.</li> </ul>
Slide Show does not run on an external video device	<ul style="list-style-type: none"> <li>■ Adjust the camera Video Out setting to NTSC or PAL (see <a href="#">page 36</a>).</li> <li>■ Make sure the external device settings are correct. (See the device's user's guide).</li> </ul>

Status	Solution
Computer does not communicate with the camera	<ul style="list-style-type: none"> <li>■ Make sure the battery is charged and installed correctly (see <a href="#">page 1</a>).</li> <li>■ Turn on the camera.</li> <li>■ Make sure the USB cable model U-8 is connected to the camera and the computer. (Use a USB / A/V adapter. See <a href="#">page 46</a>.) (If using an EasyShare dock, check all cable connections. Make sure the camera is seated on the dock.)</li> <li>■ Make sure EasyShare software is installed (see <a href="#">page 45</a>).</li> </ul>

### Picture quality problems

Status	Solution
Picture is not clear	<ul style="list-style-type: none"> <li>■ To automatically set exposure and focus, press the Shutter button <b>halfway</b>. When the framing marks turn green, press the Shutter button <b>completely down</b> to take the picture.</li> <li>■ Clean the lens (see <a href="#">page 58</a>).</li> <li>■ Make sure the camera is not in Macro mode if you are more than 27.6 in. (70 cm) from your subject.</li> <li>■ Place the camera on a flat, steady surface or use a tripod (especially in high-zoom settings or in low light).</li> </ul>
Picture is too dark	<ul style="list-style-type: none"> <li>■ Reposition the camera for more available light.</li> <li>■ Use Fill flash (see <a href="#">page 9</a>) or change your position so light is not behind the subject.</li> <li>■ Move so that the distance between you and the subject is within the effective flash range. (See camera specifications starting on <a href="#">page 56</a>.)</li> <li>■ To automatically set exposure and focus, press the Shutter button <b>halfway</b>. When the framing marks turn green, press the Shutter button <b>completely down</b> to take the picture.</li> </ul>

Status	Solution
Picture is too light	<ul style="list-style-type: none"> <li>■ Reposition the camera to reduce the amount of available light.</li> <li>■ Turn the flash off (see <a href="#">page 9</a>).</li> <li>■ Move so that the distance between you and the subject is within the effective flash range. (See camera specifications starting on <a href="#">page 56</a>.)</li> <li>■ To automatically set exposure and focus, press the Shutter button <b>halfway</b>. When the framing marks turn green, press the Shutter button <b>completely down</b> to take the picture.</li> <li>■ In Auto and SCN-Custom modes, adjust the Exposure Compensation (see <a href="#">page 38</a>).</li> </ul>

### Direct printing (PictBridge enabled printer) problems

Status	Solution
Cannot find the desired picture	<ul style="list-style-type: none"> <li>■ Make sure you're not in Favorites mode.</li> <li>■ Use the Direct print menu to change the image storage location.</li> </ul>
The Direct print menu interface turns off	<ul style="list-style-type: none"> <li>■ Press any camera button to redisplay the menu.</li> </ul>
Cannot print pictures	<ul style="list-style-type: none"> <li>■ Make sure there is a connection between the camera and the printer (see <a href="#">page 47</a>).</li> <li>■ Make sure the printer and the camera have power.</li> </ul>
Camera or printer display an error message	<ul style="list-style-type: none"> <li>■ Follow the prompts to resolve the issue.</li> </ul>

# 7

## Getting help

### Camera

Email, write, or phone Kodak	<a href="http://www.kodak.com/go/contact">www.kodak.com/go/contact</a>
Get support for your product (FAQs, troubleshooting information, arrange for repairs, etc.)	<a href="http://www.kodak.com/go/v1233support">www.kodak.com/go/v1233support</a>
Purchase camera accessories (camera docks, printer docks, lenses, cards, etc.)	<a href="http://www.kodak.com/go/v1233accessories">www.kodak.com/go/v1233accessories</a>
Download the latest camera firmware and software	<a href="http://www.kodak.com/go/v1233downloads">www.kodak.com/go/v1233downloads</a>
See online demonstrations of your camera	<a href="http://www.kodak.com/go/howto">www.kodak.com/go/howto</a>

### Software

Get information on EasyShare software	<a href="http://www.kodak.com/go/easysharesw">www.kodak.com/go/easysharesw</a> (or see Help in EasyShare software)
Get help with the Windows operating system and working with digital pictures	<a href="http://www.kodak.com/go/pcbasics">www.kodak.com/go/pcbasics</a>

### Other

Get support for cameras, software, accessories, more	<a href="http://www.kodak.com/go/support">www.kodak.com/go/support</a>
Get information on Kodak EasyShare printer docks	<a href="http://www.kodak.com/go/printerdocks">www.kodak.com/go/printerdocks</a>
Get information on Kodak inkjet products	<a href="http://www.kodak.com/go/inkjet">www.kodak.com/go/inkjet</a>
Optimize your printer for truer, more vibrant colors	<a href="http://www.kodak.com/go/onetouch">www.kodak.com/go/onetouch</a>
Register your camera	<a href="http://www.kodak.com/go/register">www.kodak.com/go/register</a>

NOTE: If you have questions concerning this product, you may speak with Kodak customer support.

Australia	1800 267 588
Austria	0179 567 357
Belgium	02 713 14 45
Brazil	0800 891 42 13
Canada	1 800 465 6325
China	800 820 6027
Czech Republic	00 800 56325000
Denmark	3 848 71 30
Ireland	01 407 3054
Finland	0800 1 17056
France	01 55 1740 77
Germany	069 5007 0035
Greece	00800 44140775
Hong Kong	800 901 514
Hungary	06 80 456 325
India	91 80 41374555 (toll free 000800 440 1227)
Italy	02 696 33452
Japan	03 5540 9002
Korea	080 708 5600

Netherlands	020 346 9372
New Zealand	0800 880 120
Norway	23 16 21 33
Philippines	1 800 1 888 9600
Poland	00800 4411625
Portugal	021 415 4125
Russia	8 495 929 9166
Singapore	800 6363 036
Slovakia	00 800 56325000
Spain	91 749 76 53
Sweden	08 587 704 21
Switzerland	01 838 53 51
Taiwan	0800 096 868
Thailand	001 800 631 0017
Turkey	00800 448827073
United Kingdom	0870 243 0270
United States	1 800 235 6325
International Toll Line	+44 131 458 6714
International Toll Fax	+44 131 458 6962

## Camera specifications

**CCD**—1/1.8 in. CCD, 4:3 aspect ratio

**ISO speed**—Auto: 64–400; Manual: 64, 100, 200, 400, 800, 1600, 3200 (ISO 3200 available for picture sizes of 3.1 MP or less.)

**Taking lens**—3X optical zoom; f/3.4 (@ wide)—f/5.3 (@ telephoto); 35 mm equivalent: 37–111 mm

**Lens protection**—Built-in

**Digital zoom**—5X continuous

**Shutter speed**—8–1/1200 seconds; 1/2–8 sec. in long exposure mode

**LCD**—2.5 in. (6.35 cm) transmissive LCD, 230K pixels (960 x 240); 30 fps

**Image storage**—Optional MMC or SD Card  (The SD logo is a trademark of the SD Card Association.)

**Internal storage capacity**—32 MB internal memory (18 MB available for image storage. 1 MB equals one million bytes.)

**Image file format**—

Still: EXIF 2.21 (JPEG compression); file organization DCF

Video: QuickTime (video: CODEC MPEG-4; audio: G.711)

**Picture size**—

12 MP (4:3): 4000 x 3000 pixels

10.7 MP (3:2): 4000 x 2664 pixels

9 MP (16:9): 4000 x 2256 pixels

6 MP (4:3): 2832 x 2128 pixels

3.1 MP (4:3): 2048 x 1536 pixels

2.2 MP (3:2): 1800 x 1200 pixels

2.1 MP (16:9): 1920 x 1080 pixels

1.2 MP (4:3): 1280 x 960 pixels

**Video capture—**

1280 x 720 (HD 720p) HQ @ 30 fps

1280 x 720 (HD 720p) @ 30 fps

640 x 480 HQ @ 30 fps

640 x 480 @ 30 fps

320 x 240 @ 30 fps

**Color modes—**High Color, Natural Color, Low Color, Black & White, Sepia**Sharpness modes—**High, Normal, Low**White Balance—**Auto, Daylight, Tungsten, Fluorescent, Open Shade**Focus system—**TTL-AF (through-the-lens auto focus); Auto: Multi-Zone, Center-Zone. Working range:

23.6 in. (60 cm)—infinity @ wide, normal

23.6 in. (60 cm)—infinity @ telephoto, normal

2–27.6 in. (5–70 cm) @ wide, Macro mode

15.7–27.6 in. (40–70 cm) @ telephoto, Macro mode

32.8 ft (10 m)—infinity @ wide, Landscape mode

32.8 ft (10 m)—infinity @ telephoto, Landscape mode

**Exposure metering—**TTL-AE; Multi-Pattern, Center-Weight, Center-Spot**Exposure compensation—**+/-2.0 EV with 1/3 EV step**Capture modes—**Auto, Video, Scene modes**Burst mode—**Maximum 3 pictures @ 1.7 fps; Auto Exposure, Auto Focus, Auto White Balance executed for first shot only**Electronic Flash—**Auto flash; Auto, Fill, Red Eye, Off; Guide No. 7.7; working range: 2–14.8 ft (0.6–4.5 m) @ wide, ISO 400;

2–9.5 ft (0.6–2.9 m) @ telephoto, ISO 400

**Communication with computer**—USB 2.0 high speed (PIMA 15740 protocol) via EasyShare HDTV dock, or via USB cable model U-8 and USB / A/V adapter. Full speed via EasyShare camera dock, printer dock, or photo frame dock 2.

**Video output**—NTSC or PAL

**PictBridge support**—Yes

**Power**—Kodak Li-Ion rechargeable digital camera battery KLIC-7004; USB charging; 5V AC adapter; EasyShare camera dock, printer dock, HDTV dock, or photo frame dock 2

**Size**—4 x 2.1 x 0.9 in. (101.9 x 54.6 x 23.4 mm) @ power off

**Weight**—5.3 oz (150 g) without card or battery

**Operating temperature**—32–104° F (0–40° C)

**Tripod mount**—1/4 inch

## Care and maintenance

- If you suspect water has gotten inside the camera, remove the battery and card. Allow all components to air-dry for at least 24 hours before using the camera.
- Blow gently on the lens or LCD to remove dust and dirt. Wipe gently with a soft, lint-free cloth or an untreated lens-cleaning tissue. Do not use cleaning solutions unless designed specifically for camera lenses. Do not allow chemicals, such as suntan lotion, to contact painted surfaces.
- Service agreements may be available in your country. Contact a dealer of Kodak products for more information.
- For digital camera disposal or recycling information, contact your local authorities. In the US, visit the Electronics Industry Alliance Web site at [www.eiae.org](http://www.eiae.org) or [www.kodak.com/go/v1233support](http://www.kodak.com/go/v1233support).



## Upgrading your software and firmware

Download the latest versions of the software included on the Kodak EasyShare software CD and the camera firmware (the software that runs on the camera). Visit [www.kodak.com/go/v1233downloads](http://www.kodak.com/go/v1233downloads).

## Storage capacities

The LCD displays the approximate number of pictures (or minutes/seconds of video) remaining. For average SD card capacities, visit [www.kodak.com/go/SDcapacities](http://www.kodak.com/go/SDcapacities). Actual storage capacity varies depending on subject composition, card size, and other factors. You may be able to store more or fewer pictures and videos. Favorites take up additional space in internal memory.

## Important safety instructions



### CAUTION:

**Do not disassemble this product; there are no user-serviceable parts inside. Refer servicing to qualified service personnel. Kodak AC adapters and battery chargers are intended for indoor use only. The use of controls, adjustments, or procedures other than those specified herein may result in exposure to shock and/or electrical or mechanical hazards. If the LCD breaks, do not touch the glass or liquid. Contact Kodak customer support.**

- The use of an accessory that is not recommended by Kodak may cause fire, electric shock, or injury. For approved accessories, visit [www.kodak.com/go/accessories](http://www.kodak.com/go/accessories).
- Use only a USB-certified computer equipped with a current-limiting motherboard. Contact your computer manufacturer if you have questions.
- If using this product in an airplane, observe all instructions of the airline.
- When removing the battery, allow it to cool; it may be hot.
- Follow all warnings and instructions supplied by the battery manufacturer.
- Use only batteries approved for this product to avoid risk of explosion.

- Keep batteries out of the reach of children.
- Do not allow batteries to touch metal objects, including coins. Otherwise, a battery may short circuit, discharge energy, become hot, or leak.
- Do not disassemble, install backward, or expose batteries to liquid, moisture, fire, or extreme temperature.
- Remove the battery when the product is stored for an extended period of time. In the unlikely event that battery fluid leaks inside the product, contact Kodak customer support.
- In the unlikely event that battery fluid leaks onto your skin, wash immediately with water and contact your local health provider. For additional health-related information, contact your local Kodak customer support.
- Dispose of batteries according to local and national regulations. Visit [www.kodak.com/go/kes](http://www.kodak.com/go/kes).
- Do not charge non-rechargeable batteries.

For more information on batteries, visit [www.kodak.com/go/batterytotypes](http://www.kodak.com/go/batterytotypes).

## Battery replacement, battery life

Kodak Li-Ion rechargeable digital camera battery KLIC-7004: 220 pictures per charge. Battery life per CIPA testing method. (Approx. number of pictures in Auto mode, using 128 MB SD card.) Actual life may vary based on usage.

### Extending battery life

- Use power-saving features (see [Customizing your camera, page 34](#)).
- Dirt on the battery contacts can affect battery life. Wipe the contacts with a clean, dry cloth before loading the battery in the camera.
- Battery performance is reduced at temperatures below 41° F (5° C). When using your camera in cold weather, carry spare batteries and keep them warm. Do not discard cold batteries that do not work; when they return to room temperature, they may be usable.

## Limited warranty

Kodak warrants Kodak consumer electronic products and accessories ("Products"), excluding batteries, to be free from malfunctions and defects in both materials and workmanship for one year from the date of purchase. Retain the original dated sales receipt. Proof of the date of purchase will be required with any request for warranty repair.

### Limited warranty coverage

Warranty service is only available from within the country where the Products were originally purchased. You may be required to ship Products, at your expense, to the authorized service facility for the country where the Products were purchased. Kodak will repair or replace Products if they fail to function properly during the warranty period, subject to any conditions and/or limitations stated herein. Warranty service will include all labor as well as any necessary adjustments and/or replacement parts. If Kodak is unable to repair or replace a Product, Kodak will, at its option, refund the purchase price paid for the Product provided the Product has been returned to Kodak along with proof of the purchase price paid. Repair, replacement, or refund of the purchase price are the sole remedies under the warranty. If replacement parts are used in making repairs, those parts may be remanufactured, or may contain remanufactured materials. If it is necessary to replace the entire Product, it may be replaced with a remanufactured Product. Remanufactured Products, parts and materials are warranted for the remaining warranty term of the original Product, or 90 days after the date of repair or replacement, whichever is longer.

### Limitations

This warranty does not cover circumstances beyond Kodak's control. This warranty does not apply when failure is due to shipping damage, accident, alteration, modification, unauthorized service, misuse, abuse, use with incompatible accessories or attachments (such as third party ink or ink tanks), failure to follow Kodak's operation, maintenance or repacking instructions, failure to use items supplied by Kodak (such as adapters and cables), or claims made after the duration of this warranty.

Kodak makes no other express or implied warranty for this product, and disclaims the implied warranties of merchantability and fitness for a particular purpose. In the event that the exclusion of any implied warranty is ineffective under the law, the duration of the implied warranty will be one year from the purchase date or such longer period as required by law. The option of repair, replacement, or refund is Kodak's only obligation. Kodak will not be responsible for any special, consequential or incidental damages resulting from the sale, purchase, or use of this product regardless of the cause. Liability for any special, consequential or incidental damages (including but not limited to loss of revenue or profit, downtime costs, loss of the use of the equipment, cost of substitute equipment, facilities or services, or claims of your customers for such damages resulting from the purchase use or failure of the Product), regardless of cause or for breach of any written or implied warranty is expressly disclaimed.

### **Your rights**

Some states or jurisdictions do not allow exclusion or limitation of incidental or consequential damages, so the above limitation or exclusion may not apply to you. Some states or jurisdictions do not allow limitations on how long an implied warranty lasts, so the above limitation may not apply to you. This warranty gives you specific rights, and you may have other rights which vary from state to state or by jurisdiction.

### **Outside the United States and Canada**

In countries other than the United States and Canada, the terms and conditions of this warranty may be different. Unless a specific Kodak warranty is communicated to the purchaser in writing by a Kodak company, no warranty or liability exists beyond any minimum requirements imposed by law, even though defect, damage, or loss may be by negligence or other act.

## Regulatory compliance

### FCC compliance and advisory



Kodak EasyShare V1233 zoom digital camera

This equipment has been tested and found to comply with the limits for a Class B digital device, pursuant to Part 15 of the FCC Rules. These limits are designed to provide reasonable protection against harmful interference in a residential installation. This equipment generates, uses, and can radiate radio frequency energy and, if not installed or used in accordance with the instructions, may cause harmful interference to radio communications. However, there is no guarantee that interference will not occur in a particular installation. If this equipment does cause harmful interference to radio or television reception, which can be determined by turning the equipment off and on, the user is encouraged to try to correct the interference by one or more of the following measures: 1) reorient or relocate the receiving antenna; 2) increase the separation between the equipment and the receiver; 3) connect the equipment to an outlet on a circuit different from that to which the receiver is connected; 4) consult the dealer or an experienced radio/TV technician for additional suggestions. Any changes or modifications not expressly approved by the party responsible for compliance could void the user's authority to operate the equipment. Where shielded interface cables have been provided with the product or specified additional components or accessories elsewhere defined to be used with the installation of the product, they must be used in order to ensure compliance with FCC regulation.

### Canadian DOC statement

**DOC Class B Compliance**—This Class B digital apparatus complies with Canadian ICES-003.

**Observation des normes-Classe B**—Cet appareil numérique de la classe B est conforme à la norme NMB-003 du Canada.

## Waste Electrical and Electronic Equipment labeling



**In Europe:** For human/environmental protection, it is your responsibility to dispose of this equipment at a collection facility established for this purpose (separate from municipal waste). For more information, contact your retailer, collection facility, or appropriate local authorities; or visit [www.kodak.com/go/recycle](http://www.kodak.com/go/recycle). (Product weight: 150 g.)

## VCCI Class B ITE

この装置は、情報処理装置等電波障害自主規制協議会（VCCI）の基準に基づくクラスB情報技術装置です。この装置は、家庭環境で使用することを目的としていますが、この装置がラジオやテレビジョン受信機に近接して使用されると、受信障害を引き起こすことがあります。  
取扱説明書に従って正しい取り扱いをして下さい。

## Korean Class B ITE

이 기기는 가정용으로 전자파적합등록된 기기로서 주거지역에서는 물론 모든 지역에서 사용할 수 있습니다.

## China RoHS

### 环保使用期限 (EPUP)

在中国大陆, 该值表示产品中存在的任何危险物质不得释放, 以免危及人身健康、财产或环境的时间期限(以年计)。该值根据操作说明中所规定的产品正常使用而定。

### 有毒有害物质或元素名称及含量标识表

部件名称	有毒有害物质或元素					
	铅	汞	镉	六价铬	多溴联苯	多溴二苯醚
数码相机电路板元件	×	○	○	○	○	○
锂电池	×	○	○	○	○	○
交流变压器	×	○	○	○	○	○

○: 表示该有毒有害物质在该部件所有均质材料中的含量均在SJ/T 11363-2006规定的限量要求以下。  
×: 表示该有毒有害物质至少在该部件的某一均质材料中的含量超出SJ/T 11363-2006规定的限量要求。



USB 数据线



音频/视频电缆

## Australian C-Tick



## Russian GOST-R



Eastman Kodak Company  
Rochester, NY 14650

Фотокамера изготовлена в Китае; остальные элементы -  
AIO-40 в соответствии с маркировкой.

## MPEG-4

Use of this product in any manner that complies with the MPEG-4 visual standard is prohibited, except for use by a consumer engaging in personal and non-commercial activities.

---

# Index

## A

- A/V out, 24
- about
  - picture, video, 26
- accessories, 47
  - battery, 60
  - buying, 54
  - printer dock, 47
  - SD/MMC card, 4
- AF assist light, i
- albums
  - set, 35
  - tagging pictures for, 44
- auto, 10
  - enhancement, 18
  - focus control, 16, 31, 32, 34
  - focus framing marks, 6
  - power off, 36
- auto focus (AF)
  - zone, 32
- Auto/SCN mode button, i

## B

- backlight, 12
- battery
  - charging, 2, 3
  - expected life, 60
  - extending life, 60
  - loading, 1
  - types, 60
- beach, 11
- blur warning, 27, 33

- bookmarks, 21
- burst, 30
- button
  - auto/SCN mode, i
  - delete, 5
  - favorites mode, i
  - macro/landscape, ii
  - menu, ii
  - OK, ii
  - on/off, i
  - review, ii
  - Share, ii
  - telephoto/zoom, 7
  - video mode, i

## C

- cable
  - audio/video, 24
  - USB, 46
- camera screen
  - getting help, 13
- camera sounds, 35
- Canadian compliance, 63
- care and maintenance, 58
- charging the battery, 2, 3
- children, 12
- clock, setting, 4
- color mode, 31
- compatibility
  - docks, 49
- computer
  - connecting camera, 45



transfer to, 45  
connector, USB / A/V, 24, 46  
copy pictures  
  card to memory, 27  
  memory to card, 27  
  to computer via USB cable, 45  
cropping pictures, 17  
customer support, 55  
customize camera, 34

## D

date setting, 4  
date stamp, 31  
DC-in, i  
deleting  
  during quickview, 5  
  from internal memory, 15  
  from SD/MMC card, 15  
  protecting pictures, videos, 15  
digital image stabilization, 11  
digital zoom, 7  
  setting, 35  
displaying slide show, 22  
disposal, recycling, 58  
dock  
  compatibility, 49  
  connector, ii  
  printer, 47  
downloading pictures, 45

## E

EasyShare software, 45  
edit videos, 19  
emailing pictures, videos, 39

expected battery life, 60  
exposure  
  compensation, 38  
  long time, 30  
  metering, 32  
external video device  
  viewing pictures, videos, 24

## F

favorites  
  settings, 42  
  tagging, 41  
favorites mode button, i  
FCC compliance, 63  
feature demos, 36  
fireworks, 11  
firmware, upgrading, 59  
flash, using, 9  
flower, 11, 12  
focus  
  framing marks, 6  
format, 36  
framing grid, 38  
framing marks, 5

## G

grid, framing, 38  
guidelines, battery, 60

## H

help  
  camera help, 13  
  Web links, 54  
high ISO, 12  
histogram, 38

**I**

icon

blur, 27

icons, modes, 10

Image stabilizer, 16, 34

image storage, 35

information

about pictures, videos, 26

installing

battery, 1

SD/MMC card, 4

software, 45

internal memory

storage capacity, 59

ISO speed, 33

**K**

Kodak EasyShare software

installing, 45

upgrading, 59

Kodak Perfect Touch technology, 18

Kodak Web sites, 54

**L**

language, 36

LCD, ii

brightness, 34

dimmer, 35

reviewing pictures, 14

reviewing videos, 14

lens, i

cleaning lens, 58

loading

battery, 1

SD/MMC card, 4

software, 45

long time exposure, 30

**M**

Mac OS, installing software, 45

macro/landscape button, ii

magnify a picture, 14

maintenance, camera, 58

make picture from video, 19

manner/museum, 12

memory

inserting card, 4

storage capacities, 59

menu button, ii

menu settings, 29

microphone, i

modes, 10

auto, 10

backlight, 12

beach, 11

children, 12

digital image stabilization, 11

fireworks, 11

flower, 11, 12

high ISO, 12

manner/museum, 12

night landscape, 11

night portrait, 11

scene (SCN), 11

self-portrait, 12

snow, 11

sport, 11

text, 11

multimedia slide show, 23  
multiple selections, 26  
multi-up, 25

**N**

night landscape, 11  
night portrait, 11

**O**

OK button, ii  
on/off button, i  
online prints, ordering, 49  
optical zoom, 7  
orientation sensor, 35

**P**

panoramic pictures, 37  
Perfect Touch technology, 18  
PictBridge enabled printer, 47  
picture size, 30  
pictures  
    copying, 27  
    cropping, 17  
    emailing tagged, 39  
    Kodak Perfect Touch, 18  
    printing, 49  
    printing tagged, 39  
    protecting, 15  
    review icons, 28  
    reviewing, 14  
    storage capacity, 59  
    tagging, 44  
    taking, modes, 10  
    transfer via USB cable, 45  
pictures/video

    deleting, 15  
    playing a video, 14  
power  
    camera, 3  
printer dock, 47  
printing  
    from a card, 49  
    from computer, 49  
    optimizing printer, 54  
    order online, 49  
    PictBridge, 47  
    tagged pictures, 49  
    with EasyShare printer dock, 47  
protecting pictures, videos, 15

**Q**

quickview, using, 5

**R**

recycling, disposal, 58  
regulatory information, 63  
repair, 54  
review button, ii  
reviewing pictures/video  
    as you take them, 5  
    deleting, 15  
    LCD, 14  
    protecting, 15  
    slide show, 22  
running slide show, 22

**S**

safety, 59  
scene modes (SCN), 11  
SD/MMC card

- inserting, 4
  - printing from, 49
  - storage capacities, 59
  - select multiple pictures/videos, 26
  - self-portrait, 12
  - self-timer, 8
    - light, i
  - service and support telephone numbers, 55
  - setting
    - AF zone, 32
    - auto power off, 36
    - auto-focus, 16, 31, 32, 34
    - blur warning, 33
    - burst, 30
    - camera sounds, 35
    - color mode, 31
    - date and time, 4
    - date stamp, 31
    - digital zoom, 35
    - exposure metering, 32
    - image storage, 35
    - ISO, 33
    - language, 36
    - LCD brightness, 34
    - LCD dimmer, 35
    - long time exposure, 30
    - orientation sensor, 35
    - picture size, 30
    - picture-taking mode, 10
    - self-timer, 8
    - sharpness, 33
    - sound volume, 35
    - video out, 36
    - video size, 16, 34
    - white balance, 32
  - setting up the camera, 1
  - setting, albums, 35
  - setup menu, 34
  - shaking hand, 27
  - Share button, ii
  - sharpness, 33
  - shutter
    - problems, 51
    - self-timer delay, 8
  - slide show
    - continuous loop, 22, 23
    - running, 22
  - snow, 11
  - software
    - installing, 45
    - upgrading, 59
  - sound volume, 35
  - sounds, 35
  - specifications, camera, 56
  - sport, 11
  - status
    - blur warning, 27
  - storage capacity, 59
  - strap, 1
  - support, technical, 55
- T**
- tagging
    - favorites, 41
    - for albums, 44
    - for email, 39
    - for print, 39

taking pictures, videos, 5  
telephone support, 55  
television, slide show, 24  
text, 11  
time, setting, 4  
timer, shutter delay, 8  
tips  
    battery guidelines, 60  
    care & maintenance, 58  
transfer, via USB cable, 45  
trash can, deleting, 5  
trimming a video, 19  
troubleshooting, 50  
turning camera on and off, 3

## U

undelete, undo, 15  
upgrading software, firmware, 59  
URLs, Kodak Web sites, 54  
USB

    transferring pictures, 45  
USB, A/V out, ii

## V

VCCI compliance, 64  
video  
    action print, 20  
    copying, 27  
    edit, 19  
    emailing tagged, 39  
    light, i  
    mode button, i  
    out, 36  
    playback, 14

    protecting, 15  
    review icons, 28  
    size, 16, 34  
    storage capacities, 59  
    transfer to computer, 45  
    viewing, 14  
video bookmarks, 21  
viewing  
    by date, album, 26  
    by multi-up, 25  
    picture, after taking, 5, 14  
    picture/video information, 26  
volume, 35

## W

warranty, 61  
white balance, 32  
Windows OS, installing software, 45

## Z

zoom  
    digital, 7  
    optical, 7